

DISTRIBUTEURS COMMANDE MANUELLE

Distributeurs commande manuelle à levier | *Lever actuated valves*

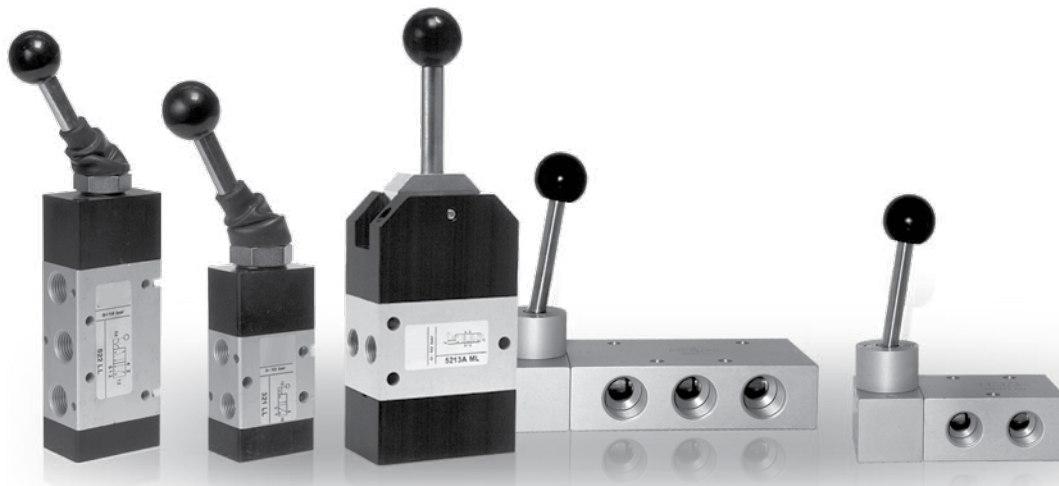

INFORMATIONS GÉNÉRALES GENERAL INFORMATION

- Distributeurs 3/2 - 5/2 - 5/3 à raccords G1/8" - G1/4" - G3/8" - G1/2" - G3/4"
 3/2 - 5/2 - 5/3 spool valves with G1/8" - G1/4" - G3/8" - G1/2" - G3/4" threaded ports
- Installation dans toutes les positions
 Installation in any position
- Large gamme de commandes
 Comprehensive range of actuations
- Versions spéciales sur demande
 Special versions on request

Matériaux

Corps : Aluminium anodisé
 Ressort : Inox
 Joints : NBR
 Tiroir : Aluminium nickelé
 Parties internes : Laiton OT58

Materials

Body : Aluminium 11S
 Springs : Stainless steel
 Seals : NBR
 Spool : Nickel plated aluminium
 Internal parts : Brass OT58

Débit à 6 bar

G1/8" : 850 NL/min G1/4" : 1700 NL/min
 G3/8" : 2250 NL/min G1/2" : 3000 NL/min
 G3/4" : 6000 NL/min

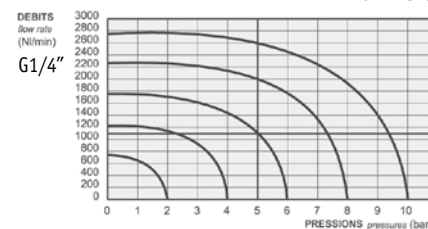
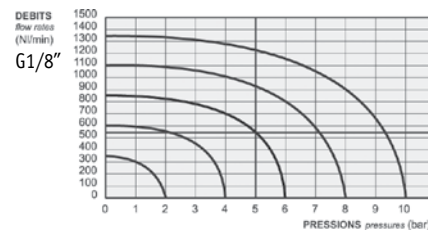

Diamètre nominal <i>Nominal orifice</i>		G1/8" : 5 mm - G1/4" : 7.5 mm - G3/8" : 10 mm G1/2" : 13 mm - G3/4" : 19 mm		
Température de travail <i>Temperature range</i>		max +60°C		
Pression de travail <i>Working pressure</i>		G1/8" - G1/4" = 0,9 à 10 bar G1/8" - G1/4" = 0,09 à 1 MPa		G3/8" - G1/2" - G3/4" = 0,9 à 10 bar G3/8" - G1/2" - G3/4" = 0,09 à 1 MPa
Force <i>Actuating force</i>	G1/8" monostable	G1/4" monostable	G1/8" bistable	G1/4" bistable
	15 N	20 N	10 N	15 N
Fluide <i>Fluid</i>		air filtré 50µ avec ou sans lubrification 50µ filtered lubricated or non lubricated air		

DISTRIBUTEURS COMMANDE MANUELLE

Distributeurs commande manuelle à levier G1/2"

Lever actuated valves

HV 311 121

Distributeur 3/2 NF à levier à 90°
rappel ressort mécanique
raccordement G1/2"
5/2 lever actuated valve
spring return
G1/2"

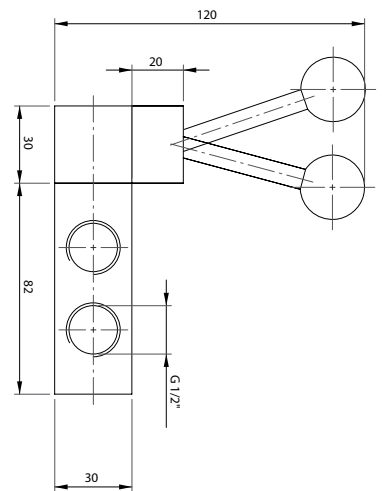
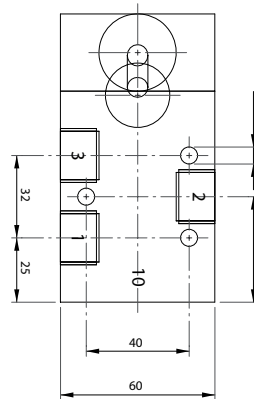
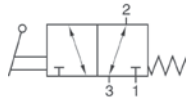

HVR 320 121

Distributeur 3/2 à levier à 90°
bistable
raccordement G1/2"
5/2 lever actuated valve
bistable
G1/2"

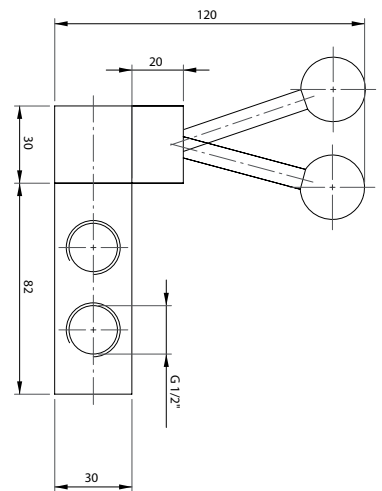
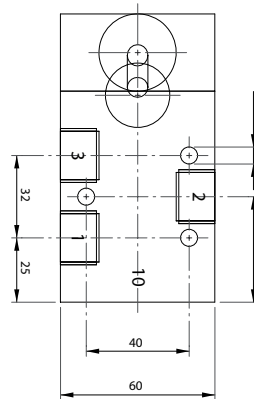
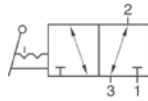

HV 511 121

Distributeur 5/2 à levier à 90°
rappel ressort mécanique
raccordement G1/2"
5/2 lever actuated valve
spring return
G1/2"

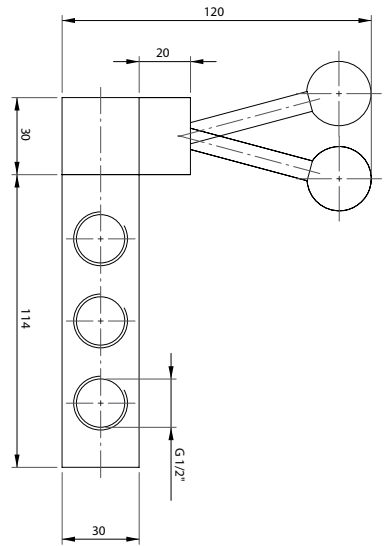
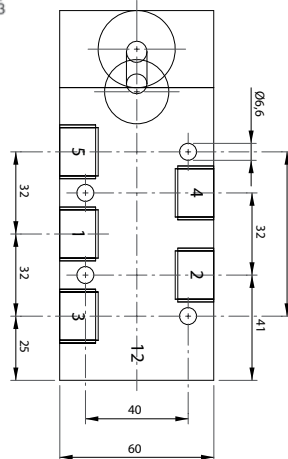
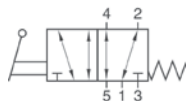
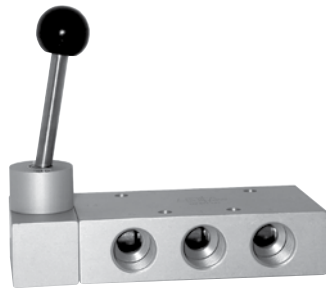

HVR 520 121

Distributeur 5/2 à levier à 90°
bistable
raccordement G1/2"
5/2 lever actuated valve
bistable
G1/2"

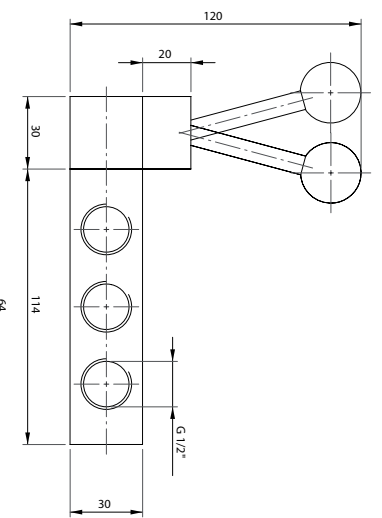
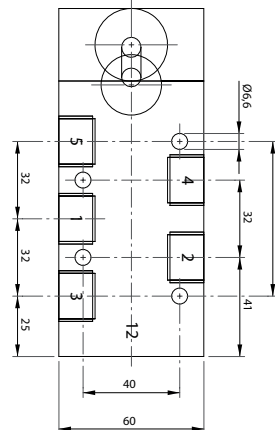
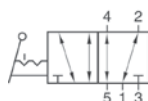
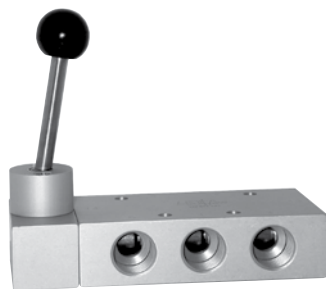

DISTRIBUTEURS COMMANDE MANUELLE

Distributeurs commande manuelle à levier G1/2"

Lever actuated valves

HV 531 121

Centre fermé
Closed center

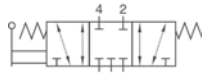

HV 532 121

Centre ouvert
Open center



HV 533 121

Centre en pression
Pressurized center

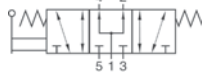

Distributeur 5/3 à levier 90°
rappel au centre
raccordement G1/2"
*5/3 lever 90°
spring return to center
G1/2"*

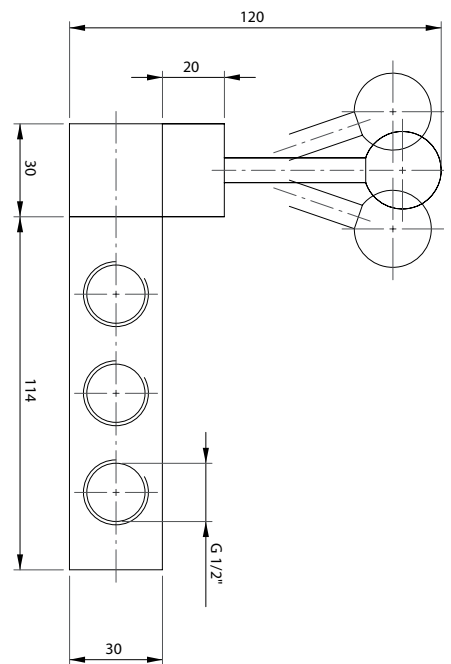
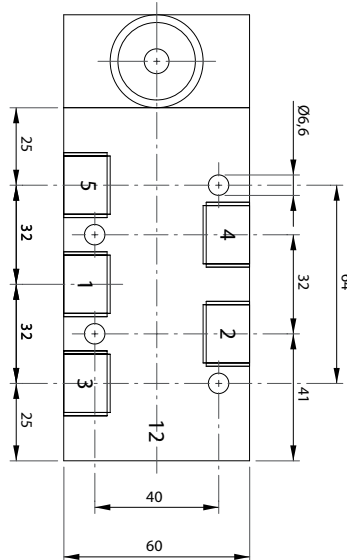
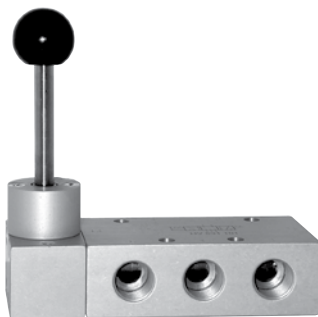

HVR 531 121

Centre fermé
Closed center

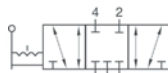

HVR 532 121

Centre ouvert
Open center



HVR 533 121

Centre en pression
Pressurized center



Distributeur 5/3 à levier 90°
3 positions fixes
raccordement G1/2"
*5/3 lever 90°
three detented positions
G1/2"*

